

Actuator IC 20

OPERATING INSTRUCTIONS

Cert. Version 08.22 · Edition 08.22 · EN · 03251436



1 SAFETY

1.1 Please read and keep in a safe place



Please read through these instructions carefully before installing or operating. Following the installation, pass the instructions on to the operator. This unit must be installed and commissioned in accordance with the regulations and standards in force. These instructions can also be found at www.docuthek.com.

1.2 Explanation of symbols

1, 2, 3, a, b, c = Action

→ = Instruction

1.3 Liability

We will not be held liable for damage resulting from non-observance of the instructions and non-compliant use.

1.4 Safety instructions

Information that is relevant for safety is indicated in the instructions as follows:

⚠ DANGER

Indicates potentially fatal situations.

⚠ WARNING

Indicates possible danger to life and limb.

⚠ CAUTION

Indicates possible material damage.

All interventions may only be carried out by qualified gas technicians. Electrical interventions may only be carried out by qualified electricians.

1.5 Conversion, spare parts

All technical changes are prohibited. Only use OEM spare parts.

CONTENTS

1 Safety	1
2 Checking the usage	2
3 Installation	3
4 Wiring	3
5 Commissioning	5
6 Accessories	7
7 Maintenance	7
8 Assistance in the event of malfunction	8
9 Technical data	9
10 Logistics	9
11 Disposal	10
12 Certification	10

2 CHECKING THE USAGE

Actuator IC 20 can be used in conjunction with a control element to adjust volumes of gas and air on various appliances and flue gas lines. It is designed for all applications that require precise, controlled rotary movement between 0° and 90°. If the voltage is disconnected, the actuator stops in its current position. The combination of IC 20 and butterfly valve BV.. (IB..) is designed for control ratios of up to 10:1 for gas, cold and hot air and flue gas.

In conjunction with linear flow control VFC (IFC), the actuator is designed for control ratios of up to 25:1 for gas and cold air.

This function is only guaranteed when used within the specified limits – see page 9 (9 Technical data). Any other use is considered as non-compliant.

2.1 Type code IC 20

IC 20	Actuator
07–60	Running time in s/90°
W	Mains voltage: 230 V AC, 50/60 Hz
Q	Mains voltage: 120 V AC, 50/60 Hz
2	Torque 2.5 Nm
3	Torque 3 Nm
E	Controlled by continuous signal
T	Three-point step control
R10	With 1000 Ω feedback potentiometer

2.2 Part designations

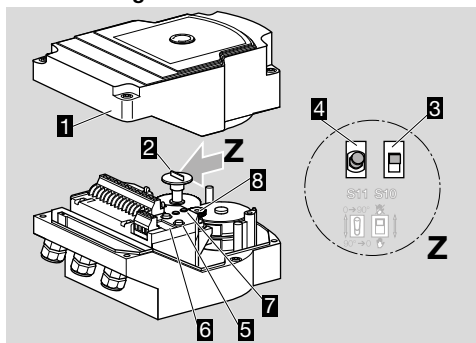

- 1 Housing cover
- 2 Position indicator
- 3 Slide switch (S10)
- 4 Toggle switch (S11)
IC 20..E:
- 5 min/max buttons
- 6 DIP switches
- 7 Red and blue LEDs
- 8 Feedback potentiometer (optional)

2.3 Type label

Mains voltage, electrical power rating, enclosure, ambient temperature, torque and installation position – see type label.

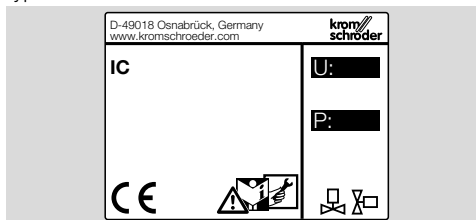

2.4 Combination of actuator with butterfly valve

Type	IC 20 + butterfly valve BV..
IBG	IC 20 + BVG (for gas)
IBGF	IC 20 + BVGF (for gas, clearance-free valve)
IBA	IC 20 + BVA (for air)
IBAF	IC 20 + BVAF (for air, clearance-free valve)
IBH	IC 20 + BVH (for hot air and flue gas)

2.5 Combination of actuator with linear flow control

Type	IC 20 + linear flow control
IFC 1	IC 20 + linear flow control VFC, size 1
IFC 3	IC 20 + linear flow control VFC, size 3

3 INSTALLATION

⚠ CAUTION

Please observe the following to ensure that the actuator is not damaged:

- Do not store or install the unit in the open air.
- Do not insulate the actuator with thermal insulation.
- Dropping the device can cause permanent damage. In this event, replace the entire device and associated modules before use.

→ Installation in the vertical or horizontal position, not upside down.

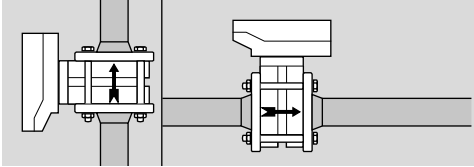

- For further information on assembly of the IC 20 with butterfly valve BV.. or linear flow control VFC, see enclosed operating instructions Butterfly valves BV.. or Linear flow controls IFC, VFC or visit www.docuthek.com.
- An adapter set is required for mounting onto butterfly valve DKL, DKG (Order No.: 74921672).
- If the actuator is to be mounted onto control elements other than DKL, DKG, BV.. or VFC, the "Single application" attachment set is required (Order No.: 74921671).

4 WIRING

⚠ WARNING

Electric shocks can be fatal!

- Before working on possible live components, ensure the unit is disconnected from the power supply.
- It must be possible to isolate the actuator from the power supply. Provide a double pole switch.
- Use temperature-resistant cable (> 90°C).
- Install supply and signal lines separately.
- Conductors which have not been connected (spare conductors) must be insulated at their ends.
- Cables should be installed well away from high-voltage lines of other devices.
- Observe EMC Directive for installation of signal lines.
- Use cables with wire end ferrules.
- Cable cross-section: max. 2.5 mm².
- When operating two or more actuators in parallel, the three-point step controller (terminals 1 and 2) must be electrically isolated to avoid leakage currents. We recommend using relays.
- Interference suppression capacitors installed in the system must only be used in conjunction with a series resistor so as not to exceed the maximum current – see page 9 (9 Technical data).
- Running times are reduced by a factor of 0.83 at 60 Hz compared to 50 Hz.
- External devices can be activated or intermediate positions can be checked via two additional, floating, infinitely adjustable switches (cams S1 and S2).
- The input signals for the actuator can be set via DIP switches. DIP switch positions that are not indicated can be freely selected, see connection diagram, page 4 (4.2 IC 20..E).
- 1 Disconnect the system from the electrical power supply.
- 2 Shut off the gas supply.
- Before opening the unit, the fitter should ground himself.

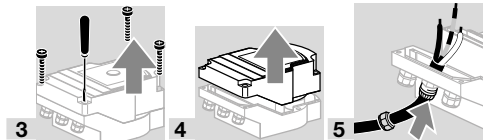

- 6 Wire as shown on the connection diagram see connection diagrams on page 4 (4.1 IC 20) and page 4 (4.2 IC 20..E).
- 7 Set switch S10 to Automatic mode.
- Voltage is applied to terminals 3 and 4.

4.1 IC 20

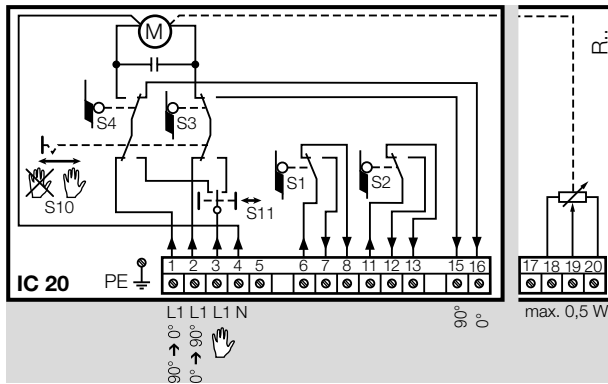

Three-point step control

- In the case of default setting "Closed":
The control element opens when voltage is applied to terminal 2.
The control element closes when voltage is applied to terminal 1.
- Terminals 6 to 13 must be operated with the same voltage potential.

Feedback

- An optional feedback potentiometer offers the option of monitoring the current position of the actuator IC 20 (Order No.: 74921144).
- The potentiometer must be utilized as a voltage divider. The change in position of the potentiometer wiper (which corresponds to the actuator position) can be measured as a changing voltage between U_- and U_M .

- Other circuit layouts produce measurement results that are inaccurate and do not remain stable over a long period of time or are non-reproducible. They also reduce the service life of the feedback potentiometer.
- The available range depends on the adjustment of switching cams S3 and S4.

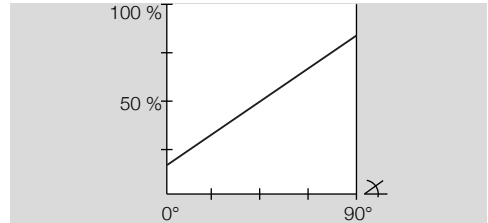

4.2 IC 20..E

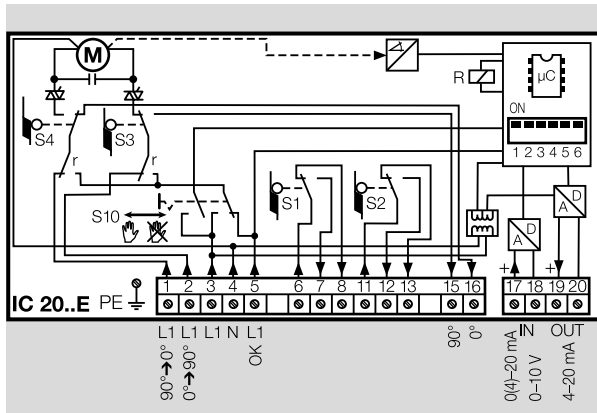

- ON 4-20 mA
- 0-20 mA
- 0-10 V
- ON 50 Ω
- 250 Ω
- ON Closed pos.
- Open pos.
- Stop
- Two-point step control

Three-point step control

- No voltage at terminal 5: three-point step control.
- Voltage must be applied to terminals 3 and 4 continuously.
- The low-fire rate (CLOSED) and the high-fire rate (OPEN) are controlled via terminals 1 and 2.

Two-point step control

- a** Connect bridge between terminals 1 and 3.

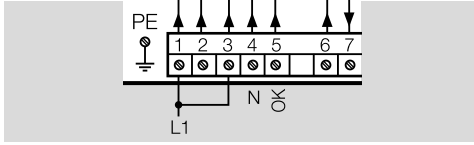

- b** Set the DIP switches to 2-point step control.

- When voltage is applied to terminal 5, the actuator opens. When no voltage is applied to terminal 5, the actuator closes.
- Terminals 17 and 18 for continuous control are not required in the case of 2-point control.

Continuous control

- Voltage at terminal 5: continuous control.
- The actuator reacts to the setpoint specification (0 (4)–20 mA, 0–10 V) via terminals 17 and 18.
- The continuous signal corresponds to the adjustment angle to be approached (e.g. with a 0 to 20 mA signal, 10 mA correspond to a valve angle of 45°).

Feedback

- Terminals 19 and 20: the IC 20..E offers the option of monitoring the current position of the actuator via the continuous 4–20 mA output signal.

Input signal

- The positioning control hysteresis can be adjusted on a potentiometer to suppress fluctuations or interference in the input signal.
- The hysteresis can be increased accordingly by turning the potentiometer clockwise.

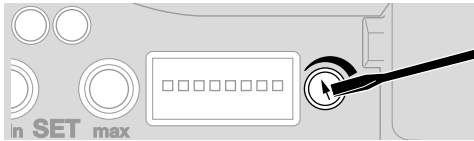

5 COMMISSIONING

⚠ CAUTION

- Please observe the following to ensure that the actuator and butterfly valve are not damaged:
- Adjusting cam S4 to an angle of less than 0° or cam S3 to an angle of over 90° can damage the actuator or butterfly valve.
- The maximum opening angle can be set using switching cam S3 and the minimum opening angle can be set using S4.
 - Switching cams S1/S2 can be optionally adjusted.

⚠ WARNING

- Risk of electric shock due to live components and cables.
- The positions in the low-fire rate range can be precisely adjusted.
- 1** Set slide switch S10 to Manual mode. The blue LED lights up.

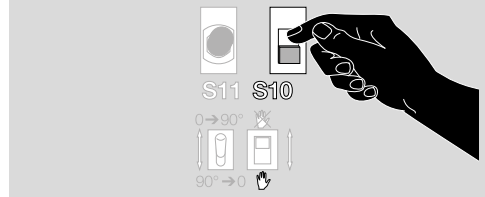

- 2** Voltage must be continuously applied to the actuator (terminals 3 and 4) to allow the control element to open.

- 3** Press toggle switch S11 upwards.



- The control element opens.
- 4** Press toggle switch S11 downwards.
- The control element closes.

Setting the maximum opening angle using switching cam S3

- Only adjust S3 between 40° and 90°.
 - Feedback signal to terminal 15.
 - S3 can only be accessed when the control element is in an open position.
- 5** Move the actuator to its maximum opening angle.
- 6** Adjust the trip point of cam S3 using a screwdriver.
- Anticlockwise = smaller opening angle.
 - Clockwise = greater opening angle.

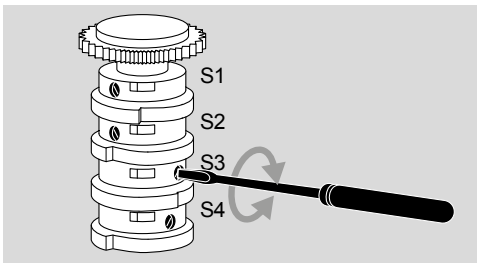

CAUTION

Remove the screwdriver again before attempting to actuate the switching cams.

Setting the minimum opening angle using switching cam S4

- Only adjust S4 between 0° and 30°.
- Feedback signal to terminal 16.
- 7 Move the actuator to its minimum opening angle.
- 8 Adjust the trip point of cam S4 using a screwdriver.

Adjusting switching cams S1/S2

- 9 Adjust the trip point of cams S1/S2 using a screwdriver.
- The cams can be adjusted over the full angle of rotation (0–90°) of the actuator.

IC 20..E: adapting the adjustment angle to the input signal in the case of continuous control

- Maximum input signal $\hat{=}$ maximum angle. Minimum input signal $\hat{=}$ minimum angle.
- The IC 20..E is in Manual mode and the blue LED is lit.

Automatic calibration

- The minimum and maximum opening angle corresponds to the setting of switching cams S3 and S4 in the case of automatic calibration.
- 1 Activate Manual mode.
- 2 Press the min and max buttons simultaneously for approx. 3 seconds until the red (R) and blue (B) LEDs flash.

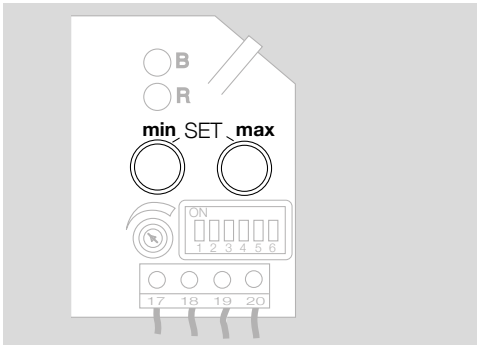

- Calibration is completed when the blue LED is lit continuously and the red LED goes out.

Manual calibration

- The minimum and maximum opening angle can be anywhere within the range set using switching cams S3 and S4.
- 1 Move the control element to the required min. position by pressing toggle switch S11.
- If the control element is already in the min. position, toggle switch S11 must still be pressed briefly.
- 2 Press the min button (approx. 3 seconds) until the blue LED goes out briefly (approx. 0.5 seconds).
- 3 Move the control element to the required max. position by pressing toggle switch S11.
- 4 Press the max button (approx. 3 seconds) until the blue LED goes out briefly (approx. 0.5 seconds).

Characteristic curve inversion

- The mA value for low fire is greater than the mA value for high fire (min. \geq max.).
- 1 Move the control element to the required min. position by pressing toggle switch S11.
- If the control element is already in the min. position, toggle switch S11 must still be pressed briefly.
- 2 Press the min button (approx. 3 seconds) until the blue LED goes out briefly (approx. 0.5 seconds).
- If the min. position is greater than or equal to the current max. position, press the min button until the red LED lights up briefly (approx. 0.5 seconds) and hold it in for approx. 3 seconds more until the blue LED goes out briefly (approx. 0.5 seconds).
- 3 Move the control element to the required max. position by pressing toggle switch S11.
- 4 Press the max button (approx. 3 seconds) until the blue LED goes out briefly (approx. 0.5 seconds).
- If the max. position is less than the current min. position, press the max button until the red LED lights up briefly (approx. 0.5 seconds) and hold it in for approx. 3 seconds more until the blue LED goes out briefly (approx. 0.5 seconds).

6 ACCESSORIES

6.1 Potentiometer installation set

- Can only be retrofitted on IC 20..T.
- The power consumption of the potentiometer is max. 0.5 W.

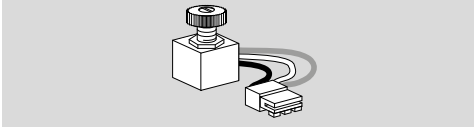

Order No.: 74921144

- Resistance value of the potentiometer – see type label.
- If the feedback potentiometer is to be retrofitted – see enclosed potentiometer operating instructions.

CAUTION

Please observe the following to ensure that the actuator is not damaged:

- Adjusting cam S4 to an angle of less than 0° or cam S3 to an angle of over 90° will damage the potentiometer.
- The available range depends on the adjustment of switching cams S3 and S4.

6.2 Adapter set for mounting onto a butterfly valve DKL, DKG

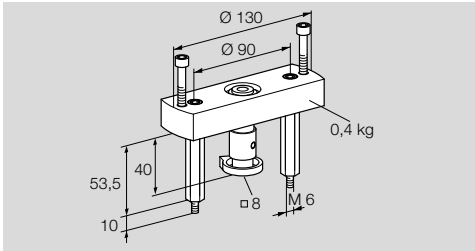

Order No.: 74921672

6.3 “Single application” attachment set

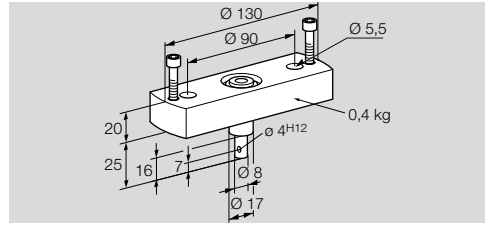

This attachment set is required if the actuator is mounted onto control elements other than DKL, DKG, BVA, BVAF, BVG, BVGF, BVH, BVHS or VFC.

Order No.: 74921671

6.4 Heat deflector

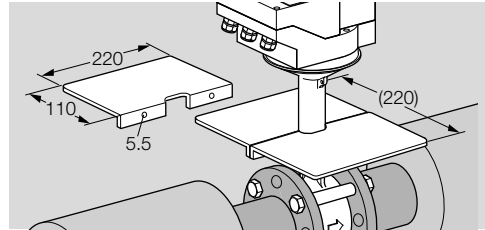

Install heat deflectors in order to protect the actuator from overheating if the medium temperature is > 250°C (482°F).

Order No.: 74921670

6.5 Fastening set for BVG, BVA, BVH

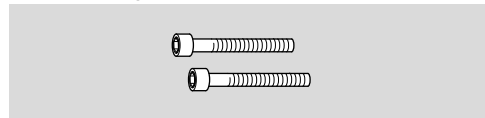

2 x M6 x 35 set screws, for retrofitting the IC 20 to the butterfly valve.

Order No.: 74921082

6.6 Cable gland with pressure equalization element

To avoid the formation of condensation, the cable gland with pressure equalization element can be used instead of the standard M20 cable gland. The diaphragm in the gland is designed to ventilate the device, without allowing water to enter.

1 x cable gland, Order No.: 74924686

7 MAINTENANCE

Actuators IC 20 suffer little wear and require little servicing. We recommend a function check once a year.

8 ASSISTANCE IN THE EVENT OF MALFUNCTION

DANGER

Electric shocks can be fatal!

- Before working on possible live components, ensure the unit is disconnected from the power supply.

WARNING

To avoid harm to persons and damage to the unit, please observe the following:

- Never remove the circuit board!
- Unauthorized repairs or incorrect electrical connections may cause the control element to open resulting in defects.

? **Fault**

! Cause

- Remedy

? **Control element does not move.**

! The actuator is in Manual mode (IC 20..E: blue LED is lit).

- Set slide switch S10 to Automatic mode.

! No voltage at terminal 5.

- Check voltage at terminal 5.

! Motor coil or electronics defective as a result of excessive ambient temperature and/or excessive operating voltage.

- Check ambient temperature and/or operating voltage, see type label or page 9 (9 Technical data).

! Cam trip points maladjusted. S4 has been set to a wider angle than S3 (IC 20..E: red LED lights up, blue LED flashes once if the unit has been automatically calibrated).

- Adjust the trip points, see page 5 (5 Commissioning). Then calibrate the IC 20..E.

! Electrical fault!

- Remember the minimum distance from ignition cables.

IC 20..E

! DIP switch position is incorrect.

- Set correct input signal using the DIP switches.

! The adjustment range has been set too small during manual calibration. The red LED flashes three times.

- Increase adjustment range using min and max buttons, see page 5 (5 Commissioning).

! The input signal on the 4–20 mA setpoint input is < 3 mA. The red LED flashes once.

- Check input signal, remedy cable discontinuity.

? **The motor and drive shaft of the actuator no longer function as required.**

! The gear is defective.

- Remove the unit and return it to the manufacturer.

! Gear load is too great.

- Check the torque – see type label.

? **Feedback potentiometer indicates incorrect values.**

! Potentiometer is moving against its mechanical stop.

- Install the potentiometer correctly – see potentiometer operating instructions.

! Connections on the terminal strip mixed up.

- Check the contact assignment on the terminal strip.

! Incorrect potentiometer utilization.

- Utilize the potentiometer as a voltage divider.

! The windings in the potentiometer are defective.

- Replace the potentiometer – see potentiometer operating instructions.

? **Control element moves constantly.**

! IC 20..E: current signal fluctuates. The red LED flashes twice.

- Check control loop, if possible, attenuate it.
- Increase the hysteresis using the potentiometer, see paragraph "Input signal" in section page 4 (4.2 IC 20..E).

! IC 20: 3-point step signal fluctuates.

- Check/adjust the 3-point step controller.

? **Is it not possible for the fault to be eliminated with the measures described above?**

! IC 20..E: internal error. The red LED lights up, the blue LED flashes twice.

- Remove the unit and return it to the manufacturer for inspection.

9 TECHNICAL DATA

WARNING

Information pursuant to REACH Regulation No. 1907/2006, Article 33.

The device contains substances of very high concern which are listed in the Candidate List of the European REACH Regulation No. 1907/2006.

9.1 Ambient conditions

Icing, condensation and dew in the unit are not permitted.

Avoid direct sunlight or radiation from red-hot surfaces on the unit.

Note the maximum medium and ambient temperatures.

Avoid corrosive influences, e.g. salty ambient air or SO₂.

The unit may only be stored/installed in enclosed rooms/buildings.

Enclosure: IC 20 in conjunction with BVH or BVHS: IP 65,

IC 20 in conjunction with butterfly valves mounted to the IC 20 housing without a seal: IP 54, in conjunction with BVH: IP 65.

Safety class: I.

This unit is not suitable for cleaning with a high-pressure cleaner and/or cleaning products.

Ambient temperature:

-20 to +60°C, no condensation permitted.

Storage temperature: -20 to +40°C.

Transport temperature = ambient temperature.

9.2 Mechanical data

Angle of rotation: 0–90°, adjustable.

Holding torque = torque.

Type	Running time [s/90°]		Torque [Nm]	
	50 Hz	60 Hz	50 Hz	60 Hz
IC 20-07	7.5	6.25	2.5	2
IC 20-15	15	12.5	3	3
IC 20-30	30	25	3	3
IC 20-60	60	50	3	3

9.3 Electrical data

Mains voltage:

120 V AC, -15/+10%, 50/60 Hz,

230 V AC, -15/+10%, 50/60 Hz.

Screw terminals using the elevator principles for cables up to 4 mm² (single core cables) and for cables up to 2.5 mm² with wire end ferrules.

Contact rating of the cam switches:

Voltage	Min. current (resistive load)	Max. current (resistive load)
24–230 V, 50/60 Hz	1 mA	2 A
24 V DC	1 mA	100 mA

Duty cycle: 100%.

Electrical connection:

Line entrance: 3 x M20 plastic cable glands.

IC 20

Power consumption:

4.9 VA at 50 Hz, 5.8 VA at 60 Hz.

Resistance of the feedback potentiometer:

1 kΩ, max. 0.5 W.

IC 20..E

Power consumption:

terminals 1, 2 and 5:

4.9 VA at 50 Hz, 5.8 VA at 60 Hz,

terminal 3:

8.4 VA at 50 Hz, 9.5 VA at 60 Hz,

in total not exceeding:

8.4 VA at 50 Hz, 9.5 VA at 60 Hz.

Feedback output: electrically isolated,

max. 500 Ω load impedance.

The output is always active when mains voltage is applied to terminal 3.

Input: electrically isolated,

4 (0)–20 mA: load impedance switchable between

50 Ω and 250 Ω,

0–10 V: 100 kΩ input resistance.

9.4 Designed lifetime

The following specifications on the designed lifetime of the actuator relate to typical applications with butterfly valves BVG, BVA, BVH and VFC.

Typical designed lifetime of the cam switches:

Switching current	Switching cycles	
	cos φ = 1	cos φ = 0.3
1 mA	1,000,000	–
22 mA ¹⁾	–	1,000,000
100 mA	1,000,000	–
2 A	100,000	–

¹⁾ Typical contactor application (230 V, 50/60 Hz, 22 mA, cos φ = 0.3)

10 LOGISTICS

Transport

Protect the unit from external forces (blows, shocks, vibration).

Transport temperature: see page 9 (9 Technical data).

Transport is subject to the ambient conditions described.

Report any transport damage on the unit or packaging without delay.

Check that the delivery is complete.

Storage

Storage temperature: see page 9 (9 Technical data).

Storage is subject to the ambient conditions described.

Storage time: 6 months in the original packaging before using for the first time. If stored for longer than this, the overall service life will be reduced by the corresponding amount of extra storage time.

11 DISPOSAL

Devices with electronic components:

WEEE Directive 2012/19/EU – Waste Electrical and Electronic Equipment Directive



At the end of the product life (number of operating cycles reached), dispose of the packaging and product in a corresponding recycling centre. Do not dispose of the unit with the usual domestic refuse. Do not burn the product. On request, old units may be returned carriage paid to the manufacturer in accordance with the relevant waste legislation requirements.

12 CERTIFICATION

12.1 Certificate download

Certificates – see www.docuthek.com

12.2 Declaration of conformity



We, the manufacturer, hereby declare that the product IC 20 complies with the requirements of the listed Directives and Standards.

Directives:

- 2014/35/EU – LVD
- 2014/30/EU – EMC
- 2011/65/EU – RoHS II
- 2015/863/EU – RoHS III

Standards:

- EN 60730:2011

Elster GmbH

12.3 ANSI/CSA approved

IC 20..Q (120 V AC) only



Canadian Standards Association – ANSI/UL 429 and CSA C22.2

12.4 Eurasian Customs Union



The products IC 20 meet the technical specifications of the Eurasian Customs Union.

12.5 China RoHS

Directive on the restriction of the use of hazardous substances (RoHS) in China. Scan of the Disclosure Table China RoHS2, see certificates at www.docuthek.com.

FOR MORE INFORMATION

The Honeywell Thermal Solutions family of products includes Honeywell Combustion Safety, Eclipse, Exothermics, Hauck, Kromschroder and Maxon. To learn more about our products, visit ThermalSolutions.honeywell.com or contact your Honeywell Sales Engineer.

Elster GmbH
Strothweg 1, D-49504 Lotte
T +49 541 1214-0
hts.lotte@honeywell.com
www.kromschroeder.com

Global centralized service deployment coordination:
T +49 541 1214-365 or -555
hts.service.germany@honeywell.com

Translation from the German
© 2022 Elster GmbH

Honeywell
kromschroder